

Model RE-80 RCA Victrola

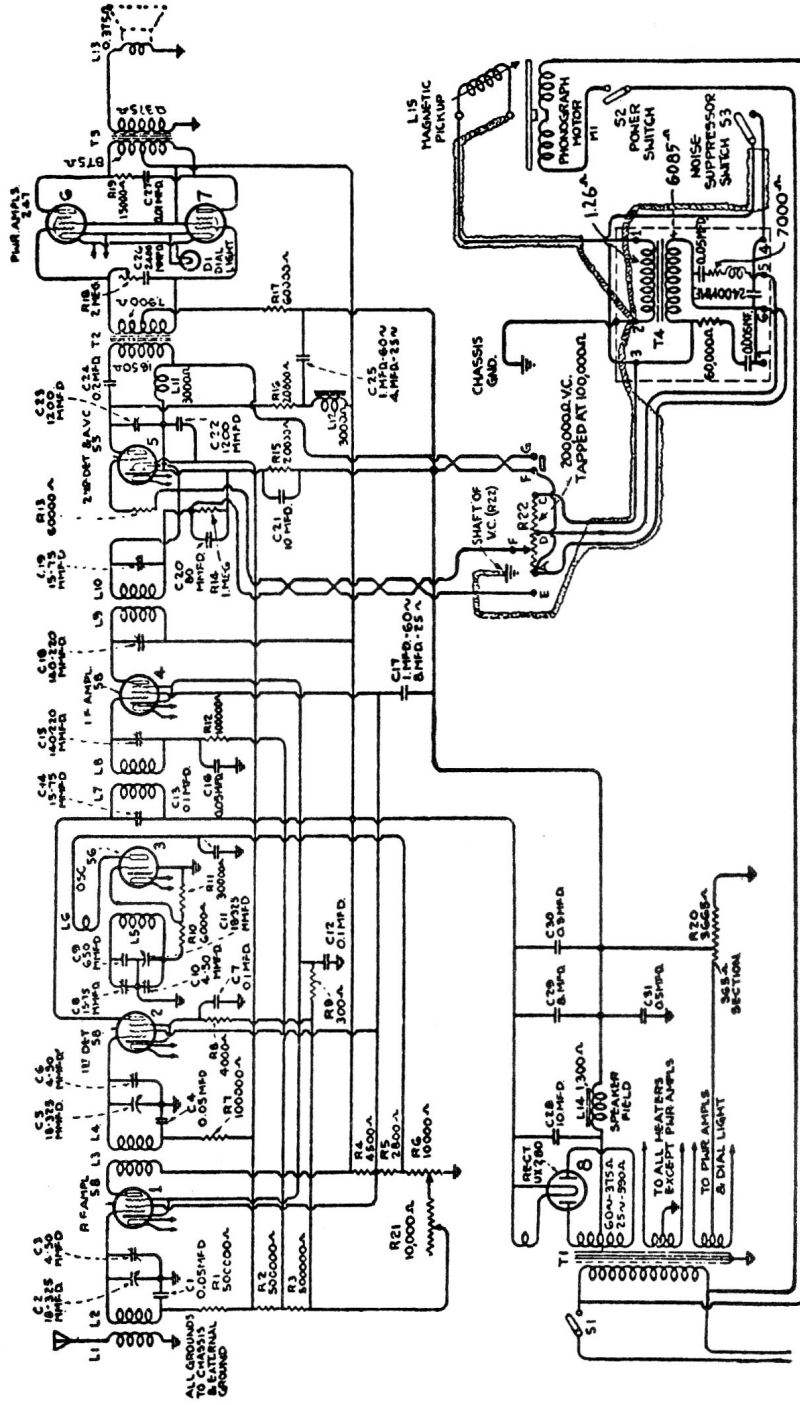

ALIGNMENT PROCEDURE

R.F. & Det. Stages 1400 K.C.
 Oscillator Stage 600 K.C., 1400 K.C.
 Intermediate Frequency 175 K.C.
 Align all stages for maximum peak.